

MODEL	DESCRIPTION
VSX..	two-way valve DN 1/2" - 3/4"; Kvs m ³ /h 0,25 - 6
VMX..	three-way valve DN 1/2" - 3/4"; Kvs m ³ /h 0,25 - 6 (4 angle way)
VTX..	three-way valve with built in by-pass DN 1/2" - 3/4"; Kvs m ³ /h 0,25 - 6 (4 angle way)

APPLICATION AND USE

Micra® valves are employed for the control of chilled and heated water in heating and air-conditioning plants; they are motorized by MVX and MCA electro-thermal actuators (MCA230Lx, MCA24Lx, MVX22R, MVX42R, MVX52).

Micra® valves extremely reduced dimensions enable an easy mounting on terminal unit coils.

Special applications

Thermal insulation for cool water applications is available on request. Moreover, it is possible to order a kit for fan coil installation, which can be customized according to the various vendors' requirements. For further information, please contact our Technical Support.

MANUFACTURING CHARACTERISTICS

Brass valve body. Fortron plug with EPDM double OR. Stainless steel stem. Stem packing with EPDM double OR. All models are normally closed, i.e. the action of the valve spring makes the plug move to the upper seat, even with disassembled actuator.

TECHNICAL CHARACTERISTICS

Operating pressure:	1600kPa
Stroke:	2,5mm
Max. fluid speed:	3m/s
Allowed fluids:	Water, water+glycol (30% max.)
Temperature:	5T95°C
Leakage:	0 (tight close-off on direct and angle way)

OPERATION

Micra are valves with tight close-off on both direct and angle way. A soft tight between seat and plug ensures high performances; the action of the spring located on the valve, ensures tight close-off in compliance with the values above, even with disassembled actuator.

The plug operation is carried out by the electrothermic actuator which applies a 140N thrust.

Micra® valves can be motorized through MVX and MCA® actuators (on/off or proportional 0-10V, 24 or 230V depending on the models; MCA® can also be equipped with an auxiliary microswitch); the valve/actuator assembly is in any case very easy. For further information about actuators please refer to the following data sheets: MVX_DBL418e and MCA_DBL400e.

Controlli S.p.A.
16010 Sant'Olcese (GE)
Tel. 010 73 06 1
Fax. 010 73 06 870/871
www.controlli.eu



INSTALLATION AND MOUNTING

Before mounting, make sure pipes are clean, free from weld slag, perfectly aligned with the valve body and not subjected to vibrations.

The declared protection degree (IP44) is granted if the valve is mounted with the actuator upwards. The actuator is able to operate in any mounting position, but it is advisable not to install it downwards.

Three-way valves should be preferably used as mixing valves. In case they are mounted as diverting (i.e. an inlet and two outlets) the max differential pressure for normal operation must be reduced to one third of the specified value.

While mounting, respect the fluid directions indicated by the arrows on the valve body.

N.B.: Micra® if coupled with unpowered MVX actuator are normally closed; if coupled with unpowered MCA actuator are normally open.

APPLICATION DIAGRAMS for valves mounted as mixing

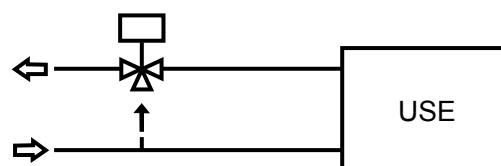

ACCESSORIES

VXC Manual Override



FITTINGS				
CODE	DN	a	b	Pack quantity
911-2078-010	15 (1/2")	G 1/2"	R 3/8"	10
911-2079-010	20 (3/4")	G 3/4"	R 1/2"	

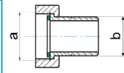

AVAILABLE MODELS

Model	Kvs [m³/h]		Close-off [bar]	Connections (*)
	direct way	angle way		
Two-way valves				
VSX09P	0,25	--	4	G1/2M
VSX10P	0,4			
VSX11P	0,6			
VSX12P	1			
VSX13 VSX13P	1,6		3,5	
VSX21 VSX21P	2,5		3,5	
Three-way valves				
VMX09P	0,25	0,25	4	G1/2M
VMX10P	0,4	0,4		
VMX11P	0,6	0,6		
VMX12P	1	0,6		
VMX13 VMX13P	1,6	1	3,5	
VMX21 VMX21P	2,5	1,6	3,5	
Three-way valves with built-in by-pass (4 ports)				
VTX09P	0,25	0,25	4	G1/2M
VTX10P	0,4	0,4		
VTX11P	0,6	0,6		
VTX12P	1	0,6		
VTX13 VTX13P	1,6	1	3,5	
VTX09P4	0,25	0,25	4	
VTX10P4	0,4	0,4		
VTX11P4	0,6	0,6		
VTX12P4	1	0,6	3,5	
VTX13P4	1,6	1		
VTX21 VTX21P VTX21P4	2,5	1,6	3,5	G3/4M

(*) The connections of models having "P" ending are suitable for flat gasket tight; the others for conic tight.

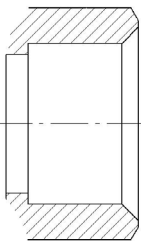

Conic tight

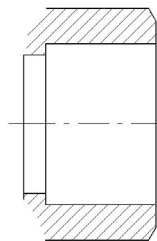

Flat tight

DIMENSIONS [mm]

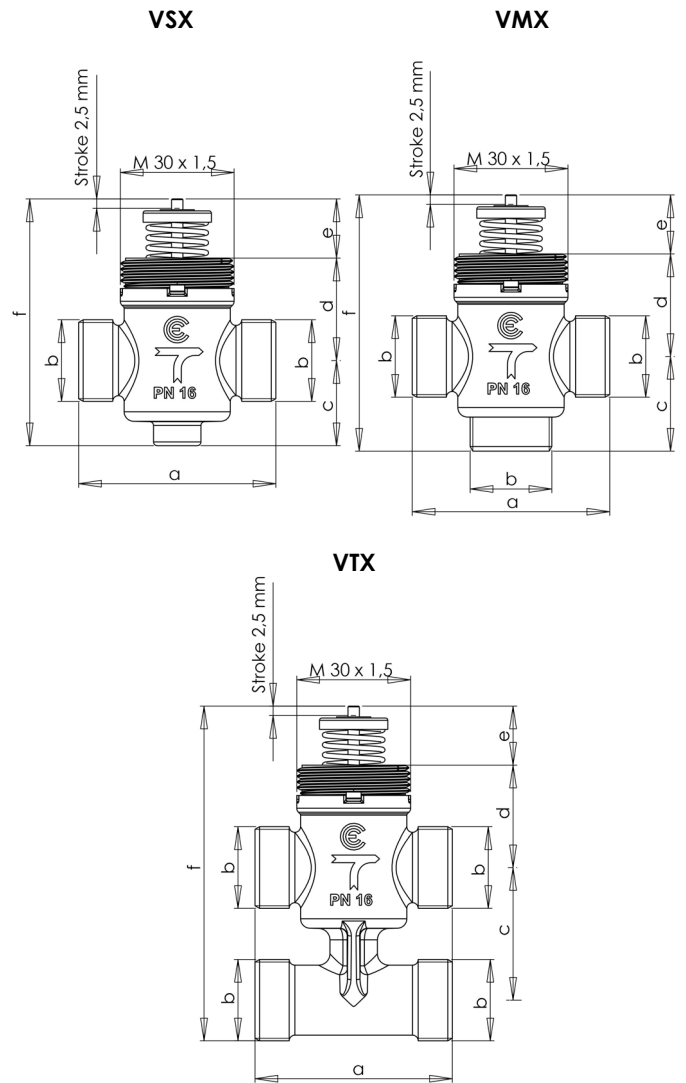

Model	a	b	c	d	e	f
VSX09P - VSX10P	52	G1/2"A	22,5	27	15,6	65
VSX11P - VSX12P						
VSX13P - VSX13						
VSX21 - VSX21P	56	G3/4"A	23,6	25,8		

Model	a	b	c	d	e	f
VMX09P - VMX10P	52	G1/2"A	25	27	15,6	65
VMX11P - VMX12P						
VMX13P - VMX13						
VMX21 - VMX21P	56	G3/4"A	34	25,8		75,4

Model	a	b	c	d	e	f	
VTX09P - VTX10P	52	G1/2"A	35	27	15,6	88,4	
VTX11P - VTX12P							
VTX13P - VTX13							
VTX09P4 - VTX10P4	56	G1/2"A	40			25,8	98,4
VTX11P4 - VTX12P4							
VTX13P4 - VTX13P4							
VTX21 - VTX21P	56	G3/4"A	50	25,8		98,4	
VTX21P4	56	G3/4"A	40	25,8		88,4	

V.X+MVX22-42R (140N)

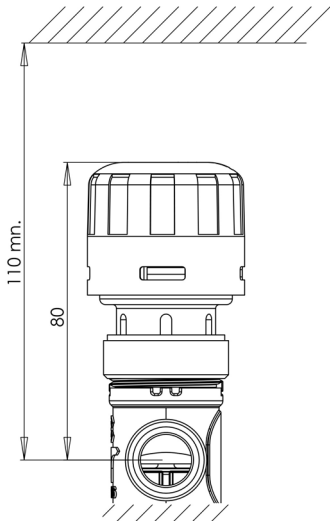

V.X+MVX52 (140N)

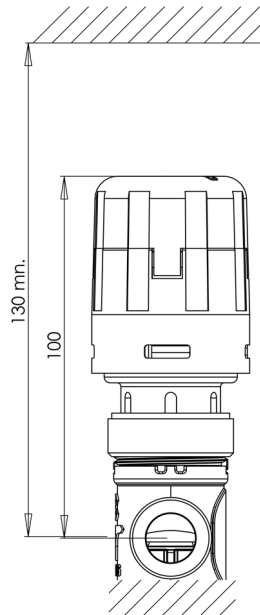

V.X+MCA.L (140N)

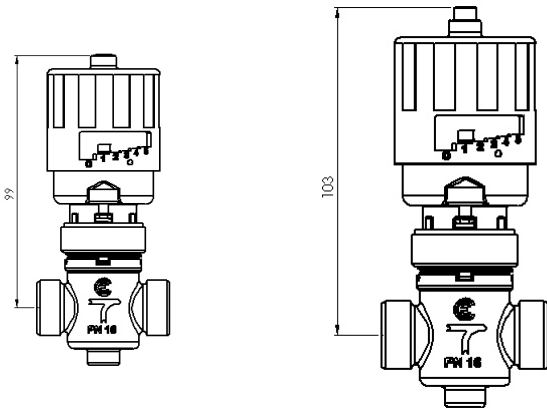

PRESSURE DROP DIAGRAM

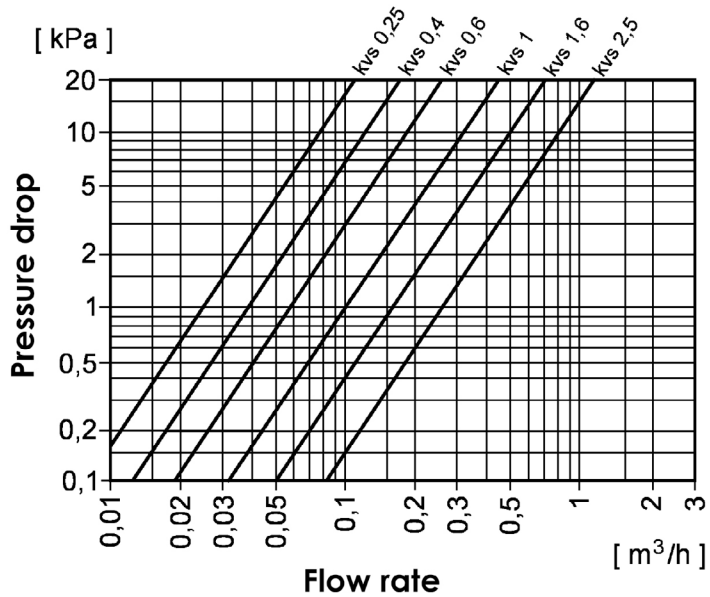

The performances stated in this sheet can be modified without any prior notice